

More information www.umbrosa.com

Plus d'infos

Weitere Informationen

Más información

Più informazioni

SAIL TRIANGLE

INSAIT

MANUAL

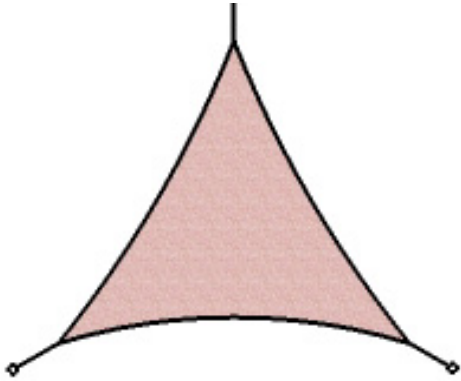

A

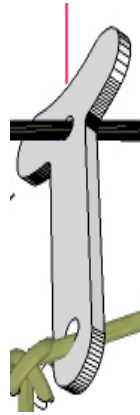

B x 3

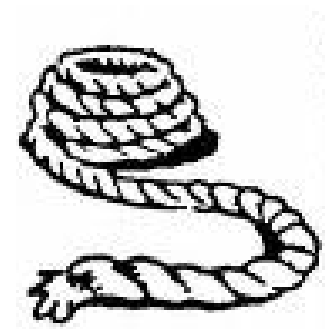

C – 2m rope x3



D

General installation

Distance between poles or fixation points
= side + 80 cm

Useful rope length of 50 to 60 cm (distance
between sail point and fixation point)

Fixation points that lie on the bisecting line (= imaginary line which
divides the angle into two even parts: see dotted line)

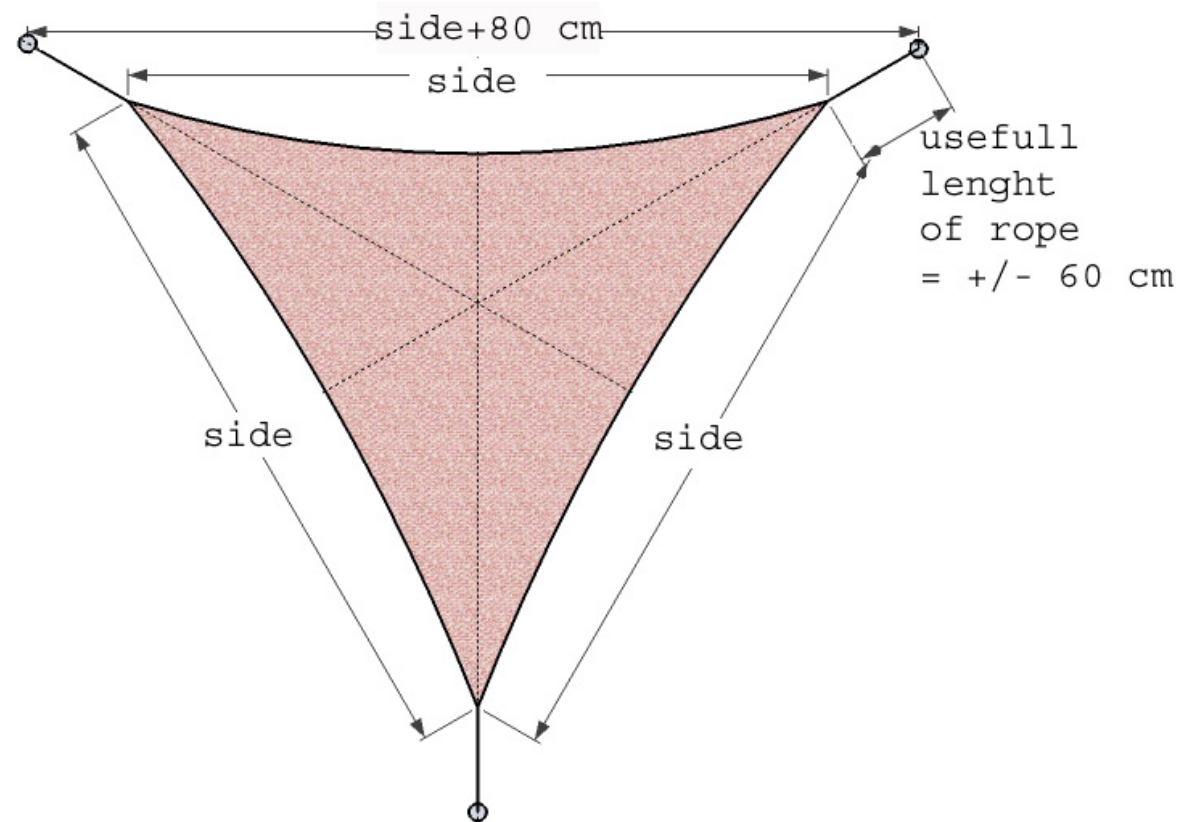

INSTALLATION POLE 75°

If mounted on sloping poles (75°), the distance between the fixation points can optionally be reduced to minimal 'side + 40 cm'

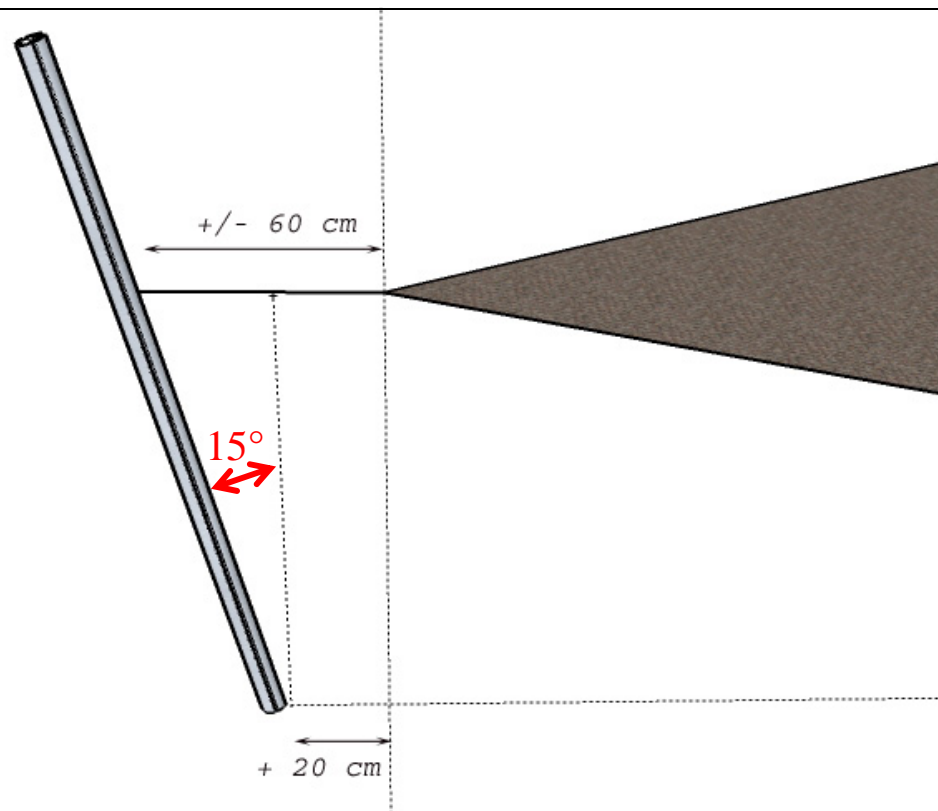

REPOSITION FIXATION POINT

<p>If required, one or more of the fixation points can be shifted in relation to the initially fixed position, provided the fixation point always lies on the bisecting line.</p>	<p>Length of the tightening rope = min. 50 to 60 cm</p>	<p>Can be extended up to 1.5 metres with the rope that is a standard accessory (delivered length of rope = 2 metres - {min} return rope for rope tightener)</p>
---	---	---

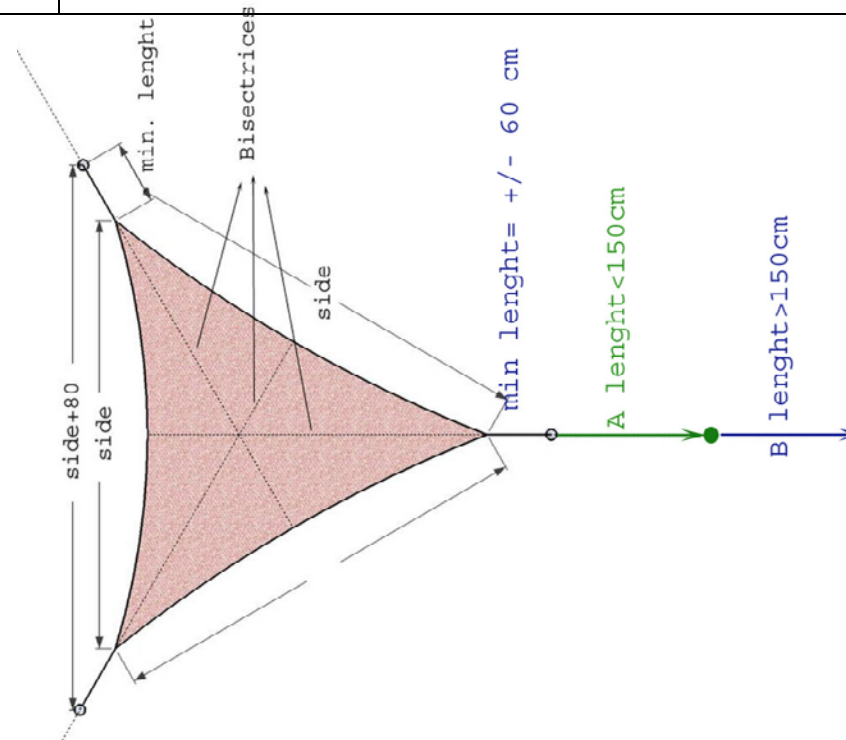

EXEPTIONS POSITION
WITH EXTRA ROPE

CORDLESS FIXATION

For each sail, only one sail point can be coupled directly to a fixation point without rope. So on the condition that the remaining sail points can be brought under tension by means of a rope.

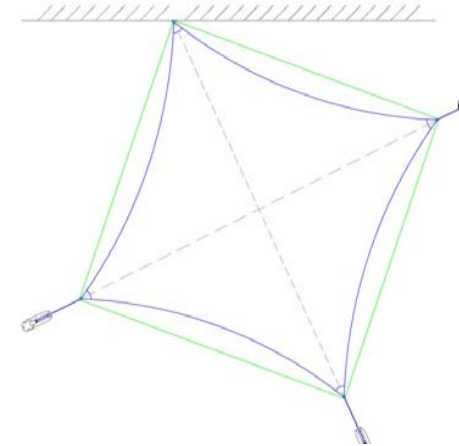
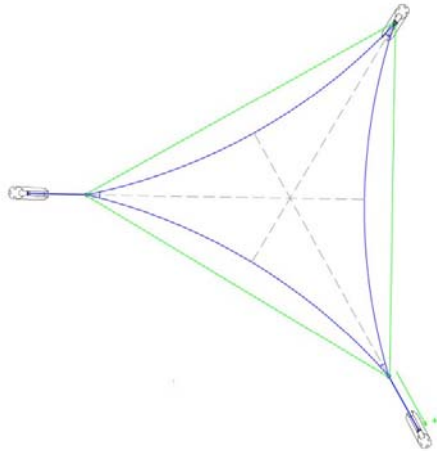

WALL FIXATION

Should existing constructions be used for the fixation of the sail, start by indicating one or two points, starting from the existing construction. Next, position an equilateral triangle with the required side and also determine the bisecting Lines.

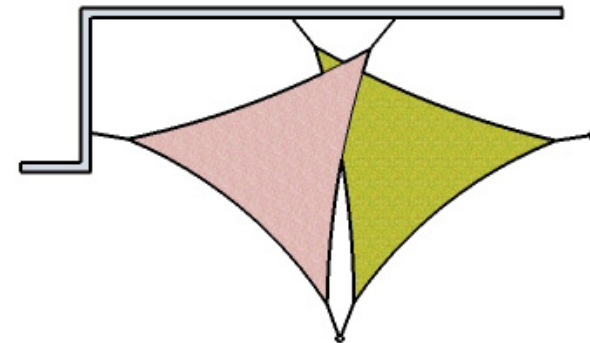
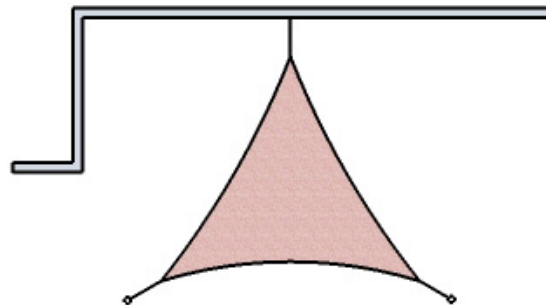
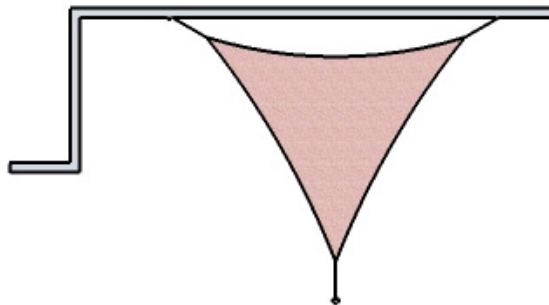

FIXATION SAIL ON POLE OR WALL

- | | |
|--------------------|---|
| 1. Bayonet hook | A. Shortening rope according to necessity |
| 2. Tightener | B. stretching |
| 3. Tightening rope | C. relaxing |
| 4. Hook shade sail | |
| 5. Sliding unit | |

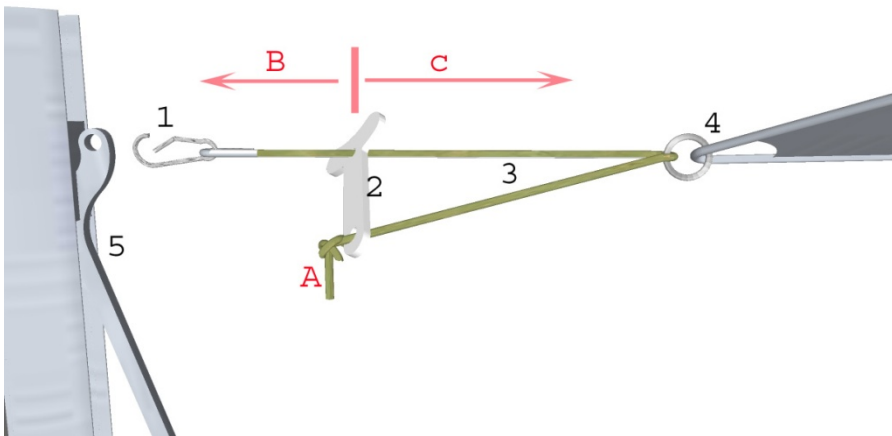

ATTENTION: THIS PART IS NOT INCLUDED WITH THE SAIL



1. Pull on hip height
2. Push up

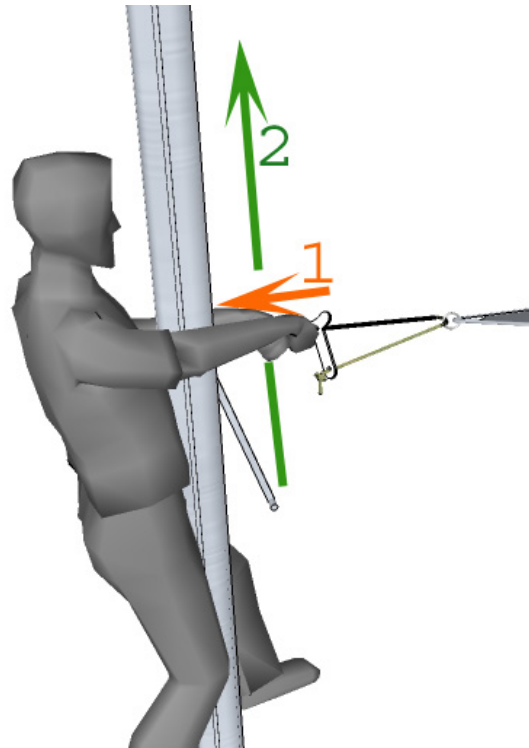

Important details

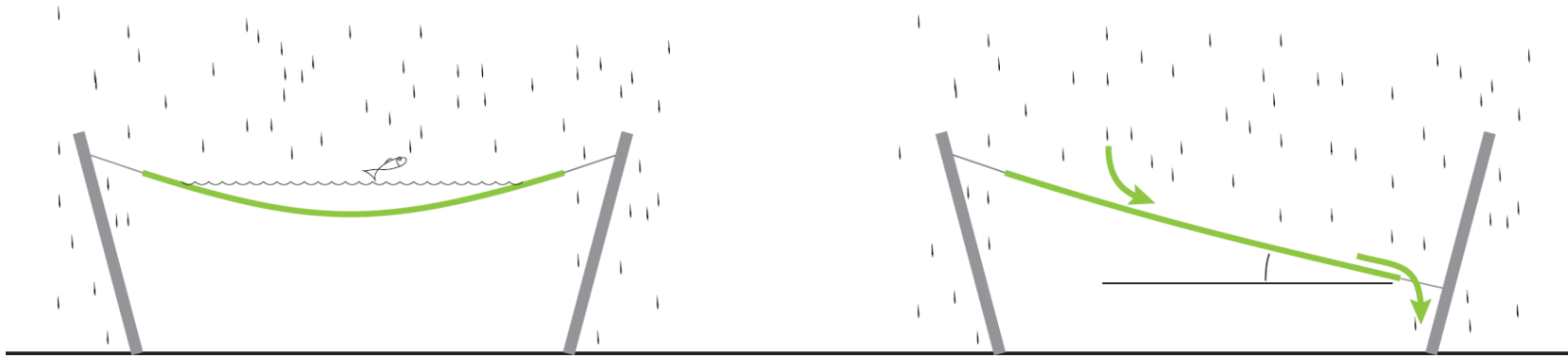

$b \pm 2\% = \checkmark$

